



Module Five of Ten

Operating Microfilming Equipment— Cameras

TRAINING *in* PRESERVATION MICROFILMING

Module Five of Ten

Operating Microfilming Equipment— Cameras

Heather Brown

National Library of Australia

2003



Published by the National Library of Australia
Canberra ACT 2600

© National Library of Australia Canberra 2003

The National Library of Australia grants permission for the reproduction and communication of this work provided that proper attribution is given. Every attempt has been made to contact the copyright holders of the graphics and excerpts contained, please contact the National Library if you have a copyright claim in materials contained in the modules.

Brown, Heather.

Training in preservation microfilming.

Bibliography.

Includes index.

ISBN 0 642 10781 5 (v. 5).

ISBN 0 642 10790 4 (set).

1. Preservation microfilming - Australia - Handbooks, manuals, etc. 2. Preservation microfilming - Australia - Problems, exercises, etc. 3. Preservation microfilming - Asia - Handbooks, manuals, etc. 4. Preservation microfilming - Asia - Problems, exercises, etc. 5. Preservation microfilming - Pacific Area - Handbooks, manuals, etc. 6. Preservation microfilming - Pacific Area - Problems, exercises, etc. I. Title.

025.84095

Contents

Introduction	1
Prerequisites	1
Learning outcomes	1
Recognition of current competencies (RCC)	1
Assessment	1
Resources	3
Topics 1, 2, 3 & 4: Camera types, reduction ratios, images per frame and image orientation	6
Performance criteria	6
Camera types	6
Features of the camera	8
Accessories	8
<i>Activity 5.1</i>	10
An ideal filming site	10
The reality—and the challenges	11
<i>Reflect 5A</i>	11
Reduction ratios	12
Tables for determining reduction ratios	13
Fixed and variable reduction ratios	14
<i>Activity 5.2</i>	14
Numbers of images per frame and image orientation	16
Orientation—quality and economics	16
<i>Activity 5.3</i>	17
Summary	17
Checklist	18
Topic 5: Operating a microfilm camera	19
Performance criteria	19
Camera lights	19
Loading cameras	22
<i>Activity 5.4</i>	24
Operating cameras—best practice principles	25
Camera step tests	27
<i>Reflect 5B</i>	28
<i>Activity 5.5</i>	28
Short cut to exposure levels	30
<i>Reflect 5C</i>	31
Black or white—copyboard colour	31
Occupational health and safety issues	31
<i>Activity 5.6</i>	33
<i>Reflect 5D</i>	34
Summary	35
Checklist	35
Topic 6: Common camera problems	36
Performance criteria	36
<i>Reflect 5E</i>	36
Special filming problems of some original materials	36
Scrapbooks, layered and oversize objects	38
Summary	40
Checklist	40
Index	41

Introduction

Welcome to **Operating Microfilming Equipment—Cameras**. This module provides you with knowledge and skills that you can apply when using a range of microfilming cameras.

Prerequisites

This is the fifth module of the training materials on preservation microfilming. Before you start on this module you need to have satisfactorily completed modules 1 and 2: **Preservation Microfilming—Basics** and **Preservation of Materials**.

It will also help if you have completed modules 3 and 4: **Preparation for Microfilming** and **Maintaining Microfilm Equipment**. These will give you related information that you will find useful before you start on this module.

Learning outcomes

When you have successfully completed this module, you will be able to:

- I determine reduction ratios and numbers of images per frame
- I determine an appropriate image orientation for a given set of originals
- I safely and efficiently operate a range of microfilm cameras.

In competency-based training models, the **learning outcomes** closely relate to the term **elements of competency**.

Recognition of current competencies (RCC)

You may already have knowledge, experience and skills which are relevant to this module.

This means that if you wish to complete a formal Preservation Microfilming course, you may not have to study all of it.

Please discuss this with your course coordinator, or lecturer. Evidence of your microfilming competence, and/or an assessment, such as a practical test, will be required.

Assessment

In order to demonstrate competency in this unit you must meet the **performance criteria** listed at the beginning and end of each topic. These form the basis of your assessment.

The performance criteria have been incorporated into a **Log book** that you will be required to complete and submit to your assessor or lecturer.

This module includes a sample of step tests for you to check using a reader.

Conditions

You will also need access to the following, either in your own workplace or by arrangement with another organisation:

- I one or more 35mm microfilm cameras
- I one or more relevant camera manuals
- I a reel of 35mm film for making tests
- I a processor to process the results of the camera tests.

Check with your lecturer/assessor or mentor if there are any problems with access to the cameras and manuals.

■ Activity

There are two types of learning activities in this module. Responses to some are written in this book. They are usually short tasks which keep you involved with the issues you are considering and may also require you to apply what you are learning.

Some of the activities in these training materials require you to perform certain tasks, such as loading a camera or operating a processor. A lecturer or assessor will observe you performing the tasks and then examine the results or the product (e.g. the newly processed microfilm) to check that it meets requirements. Major activities are marked with the symbol ★.

● Reflect

Here you will be asked to think about key issues, usually in consultation with workplace colleagues, and come to some conclusions. The purpose of these activities is to allow you to share your understanding with others, and benefit from wider experience than your own.

You will need to be prepared to discuss your findings or conclusions with your lecturer/assessor who will be signing off the relevant **performance criteria**.

▲ Submit

When this icon appears, you are ready to record in the **Log book** that you:

- I can meet the **performance criteria**
- I have satisfactorily completed the **activities** for a topic.

You can record these by marking off the boxes in the shaded columns with a ✓ **yes** or ✗ **no**.

You can then ask your lecturer or assessor to verify that you can meet the **performance criteria** and that you have satisfactorily completed the **activities**.

If you work through the various activities along the way, you will find the assessment activities relatively easy to complete.

Resources



There are a number of resources available on preservation and preservation microfilming. A librarian can help you find out where these resources are available.

Below are a few:

Printed materials

Adcock, Edward P. (ed. & comp.) 1998, *Principles for the Care and Handling of Library Material*, International Preservation Issues, number 1, IFLA-PAC, Paris.

Address: IFLA Core Programme for Preservation and Access (PAC) Bibliotheque Nationale de France, 2, rue Vivienne, 75084 Paris Cedex 02, France.

(Available online at IFLA website as *Principles for the care and handling of library material*,

<<http://www.ifla.org/VI/4/news/pchlm.pdf>>, accessed 4 May 2003.)

Canadian Cooperative Preservation Project 1993, *Guidelines for Preservation Microfilming in Canadian Libraries*, Prepared by the National Library of Canada for the Canadian Cooperative Preservation Project, Ottawa.

Elkington, Nancy E. (ed.) 1992, *RLG Preservation Microfilming Handbook*, Research Libraries Group, Mountain View, California.

Elkington, Nancy E. (ed.) 1994, *RLG Archives Microfilming Manual*, Research Libraries Group, Mountain View, California.

Fox, Lisa L. (ed.) 1996, *Preservation Microfilming: A Guide for Librarians and Archivists*, 2nd edn, ALA, Chicago.

Genealogical Society of Utah 2001, *Camera Operator's Manual*, 2nd edition update, Genealogical Society of Utah, Intellectual Reserve Inc., Salt Lake City.

Gunn, Michael J. 1985, *Manual of Document Microphotography*, Focal Press, London.

Helmer, Normandy 2001, 'Raising Lazarus: Revitalizing an in-house microfilming operation', *Microform and Imaging Review*, Vol. 30 no. 1, Spring, pp.21–27.

Langdon, Bob 1973, 'The Pacific Manuscripts Bureau' in *Source Materials Related to Research in the Pacific Area: Australian UNESCO Seminar, National Library of Australia*, September 1971, AGPS, Canberra.

Ledgerwood, Judy 1991, 'Cornell University Library's Microfilm Project in the State of Cambodia: Document Preservation under extreme circumstances', *Microform Review*, Vol. 20 no. 4, Fall, pp.167–170.

Maidment, Ewan 1998, 'Roving the Pacific: Pacific Manuscripts Bureau Microfilming in the Pacific Islands', *Microform and Imaging Review*, Vol. 27 no. 2, Spring, pp. 55–62.

Maidment, Ewan 2001, 'PAMBU: Microfilming in the Pacific Islands', *International Preservation News*, no. 24, May, pp. 7–10. (A number of back issues of International Preservation News are available direct from the IFLA website, <<http://www.ifla.org/VI/4/pac.htm4>>, accessed 12 May 2003).

Manuals for the installation and operation of microfilm cameras.

Meyer, Lars & Gertz, Janet 1993, *RLG Guidelines for microfilming to support digitization*, Research Libraries Group, Mountain View, California. Available online at

<<http://www.rlg.org/preserv/microsuppl.pdf>>, accessed 12 May 2003.

Microform and Imaging Review 1972–, (journal), quarterly, K. G. Saur, Munich, Germany.

Micrographics Year Book 1981–2001 (annual), G. G. Baker, Windlesham, Surrey, UK. (Last edition 2001).

National Library of Australia 1995, *Preservation Microfilming: Does It Have a Future?* Proceedings of the First National Conference of the National Preservation Office, at the State Library of South Australia, 4–6 May, 1994, National Library, Canberra.

National Library of Australia 1998, *Guidelines for Preservation Microfilming in Australia and New Zealand*, National Library, Canberra.

National Preservation Office 2000, *Guide to Preservation Microfilming*, The Office, London.

Saffady, William 1990, *Micrographic Systems*, 3rd edn, Association for Information and Image Management, Silver Spring, MD.

Saffady, William 2000, *Micrographics: Technology for the 21st Century*, Association of Records Managers and Administrators, Prairie Village, Kansas.

SEACAP (Southeast Asian Consortium for Access and Preservation) 2000, Proceedings of the International Meeting on Microform Preservation and Conservation Practices in Southeast Asia: Assessing Current Needs and Evaluating Past Projects, February 21–24, 2000, Chiang Mai University, Chiang Mai. (Available from the SEACAP website, <<http://www.seacap.chiangmai.ac.th>>, accessed 4 May 2003.)

Standards (relevant):

ANSI/AIIM MS23 – 1998 Standard for Information and Image Management – Standard recommended practice for production, inspection and quality assurance of first-generation silver microfilm of documents.

MP 25 – 2002 Basic Guide to microfilming – Miscellaneous Standard. Standards Australia.

See also the list of international standards in the **Learning Guide**.

Internet sites

(As internet sites change frequently, you may need to use a search engine to identify the latest location)

AICCM (Australian Institute for the Conservation of Cultural Material Inc.), <<http://www.aiccm.org.au>>, accessed 15 May 2003. Address: GPO Box 1638, Canberra ACT 2601, Australia.

AIIM (Association for Information and Image Management), <<http://www.aiim.org>>, accessed 4 May 2003, and its sub group the Film-based Imaging Association, <<http://www.fbi.aiim.wegov2.com>>, accessed 14 May 2003. The film-based imaging association has a buyers guide of U.S. manufacturers and distributors of micrographic equipment and supplies. Address: 1100 Wayne Avenue, Suite 1100, Silver Spring MD 20910 USA

ANSI (American National Standards Institute) <<http://www.ansi.org>> accessed 15 May 2003. ANSI administers and coordinates the U.S. standardisation system. Address: Customer Service, American National Standards Institute, 25 West 43rd Street, New York, NY 10036.

BSI Group (British Standards Institution), <<http://www.bsi-global.com>>, accessed 13 May 2003. The source of information and supply of British microfilming standards. BSI Group 389 Chiswick High Road, London, W4 4AL, UK.

CLIR (Council on Library and Information Resources), <<http://www.clir.org/>>, accessed 3 May 2003. Address: 1755 Massachusetts Avenue, NW, Suite 500 Washington DC 20036, USA

G.G. Baker and Associates, <<http://www.ggbaker.com/>>, accessed 15 May 2003. This organisation provides detailed advice about micrographic systems. The web site includes links to suppliers and also provides background information about areas of microfilming from jacketing to linking with electronic document management systems. Address: Saffron Hill, Chedworth, Glos. GL54 4AL UK.

IFLA (International Federation of Library Associations and Institutions) Preservation and Conservation (PAC) Core Programme, <<http://www.ifla.org/VI/4/admin/general.htm#1>>, accessed 15 May 2003.

IFLA-PAC Bibliotheque Nationale de France, Address: 2, rue Vivienne, 75084 Paris Cedex 02, France.

- See also *Principles for the care and handling of library material*, <<http://www.ifla.org/VI/4/news/pchlm.pdf>>, accessed 15 May 2003.
- A number of back issues of *International Preservation News* are available direct from the IFLA website, <<http://www.ifla.org/VI/4/pac.htm#4>>, accessed 15 May 2003.
- The IFLA-PAC Centre at the National Library of Australia maintains a *Documentary Heritage Preservation Register*. This provides information about preservation projects in the Southeast Asian and Pacific regions such as microfilming, training, basic conservation and collection surveys, <<http://www.nla.gov.au/dhpr/>> accessed 15 May 2003.

IPI (Image Permanence Institute) <<http://www.rit.edu/~661www1/>>, accessed 15 May 2003. The IPI is a university-based research laboratory devoted to image preservation. Address: Rochester Institute of Technology, 70 Lomb Memorial Drive Rochester NY 14623-5064, USA.

ISO (International Organisation for Standardisation), <<http://www.iso.ch/>>, accessed 15 May 2003. Address: ISO Central Secretariat PO Box 56 CH-1211 GENÈVE Switzerland.

Library Preservation and Conservation Tutorial – Southeast Asia. Designed for librarians and conservators in Southeast Asia, it has a range of information on preservation, including microfilming, <<http://www.librarypreservation.org/>>, accessed 15 May 2003.

The Microfilm Shop, <<http://www.microfilm.com/>>, accessed 15 May 2003. Provides product information, news and views with a focus on business applications.

MICROLINK-L is an email discussion list on preservation microfilming jointly owned by the National Library of Australia and the State Library of South Australia, <http://www.nla.gov.au/nla/listserv/microlink_l.html>, accessed 15 May 2003.

Museums Australia, <<http://amol.org.au/>>, accessed 15 May 2003. Address: PO Box K36 Haymarket NSW 1238. (The resource *ReCollections* is also available online from the Museums Australia website, <<http://amol.org.au/recollections/>>, accessed 15 May 2003.)

National Library of Australia <<http://www.nla.gov.au/>>, accessed 15 May 2003.

Address: Canberra, ACT 2600, Australia

National Library of Australia. Policy on Preservation Copying of Collection Materials, <<http://www.nla.gov.au/policy/micro.html>>, accessed 15 May 2003.

National Library of Australia. Anica – Australian Network for Information on Cellulose Acetate,

<<http://www.nla.gov.au/anica/index.html>>, accessed 15 May 2003.

See also MICROLINK-L

<http://www.nla.gov.au/nla/listserv/microlink_l.html>, accessed 15 May 2003, and IFLA-PAC Documentary Heritage Preservation Register <<http://www.nla.gov.au/dhpr/>> accessed 15 May 2003.

The National Preservation Office (UK).

Address: British Library, 96 Euston Road London, NW1 2DB, UK

<<http://www.bl.uk/services/preservation/>>, accessed 15 May 2003.

NSSN: a National Resource for Global

Standards, <<http://www.nssn.org>>, accessed 15 May 2003.

Provides a fee-based information service which includes international standards and technical data. Address: Customer Service, American National Standards Institute, 25 West 43rd Street, New York, NY 10036.

PAMBU (Pacific Manuscripts Bureau),

<<http://rspas.anu.edu.au/pambu/>>, accessed 15 May 2003. Based

in the Research School of Pacific and Asian Studies, Australian National University, the aim of the Pacific Manuscripts Bureau is to locate and preserve archives, manuscripts and other unpublished or semi-published material through microfilm.

Address: PAMBU, Research School of Pacific and Asian Studies, Australian National University, Canberra, ACT, 0200, Australia.

Preservation Resources is a division of OCLC. (Online Computer Library Center Inc.),

<<http://www.oclc.org/oclc/presres/microfilm.htm>>, accessed 15 May 2003.

It offers services such as preservation microfilming to libraries, including duplicating, scanning and polysulfide treatment.

RLG DigiNews is a newsletter conceived by the members of the Research Libraries Group's PRESERV community. Funded in part by the Council on Library and Information Resources (CLIR) from 1998–2000, it is available internationally via the RLG PRESERV web site, <<http://www.rlg.org/preserv/>>, accessed 15 May 2003. Address: Research Libraries Group 1200 Villa Street Mountain View, CA 94041-1100 USA.

SEACAP (Southeast Asian Consortium for Access and Preservation), <<http://www.seacap.chiangmai.ac.th>>, accessed 14 May 2003.

The aim of SEACAP is to encourage and support collaboration amongst libraries, archives and other institutions and interested individuals in order to preserve and provide access to the published and documentary heritage of the region.

Spring Singapore, <<http://www.psb.gov.sg>>, accessed 15 May 2003.

The source for information and supply of Singapore Codes of Practice relating to microfilming.

PSB Building, 2 Bukit Merah Central, Singapore 159835.

Standards Australia, <<http://www.standards.com.au>>, accessed 14 May 2003. Address: GPO Box 5420 Sydney NSW 2001, Australia.

UNESCO *Memory of the World Programme*,

<<http://whc.unesco.org/nwhc/pages/home/pages/homepage.htm>>, accessed 15 May 2003.

Topics 1, 2, 3 & 4

Camera types, reduction ratios, images per frame and image orientation

Performance criteria

You will have achieved the performance criteria for this topic when you can:

- I choose an appropriate camera and accessory (e.g. book cradle) for a given task
- I calculate a reduction ratio to achieve the best legibility
- I choose an image orientation to achieve the best legibility
- I choose an image orientation that achieves the most economical product.

Camera types

There are two main types of camera used for microfilming: **planetary** and **rotary**.

Rotary cameras

Rotary cameras are used for general microfilming where the emphasis is on speed, for example, filming financial documents such as bills. Documents are fed into the camera past a series of rollers and are photographed as they move through the camera.

A rotary camera is totally unsuitable for the filming of fragile documents and bound volumes, because the documents could be damaged as they physically pass through the camera. Further, the resolution levels of images from a rotary camera are generally not high due to the need to film moving documents and the camera vibration.

For these reasons rotary cameras are not suitable for preservation microfilming.

Planetary cameras

Planetary or **flat bed** cameras are the main cameras used in preservation microfilming. The items to be filmed are placed on a flat copyboard and remain still throughout the exposure. Planetary cameras are available to film either 35mm or 16mm film. Some can film both these sizes, as well as 105mm.

Planetary cameras can provide higher resolution than rotary cameras.

16mm or 35mm

Topics 4 and 5 of the first module, **Preservation Microfilming—Basics** deal with a number of factors which influence the choice of film size—35mm or 16mm. These same factors will help you choose whether a 16mm or 35mm camera is more appropriate. (Selection is simple if the camera can film both sizes.)

The camera head which houses the lens and film supply is positioned on a vertical column above the copyboard. Moving the camera head closer to, or away from the copyboard changes reduction ratios.

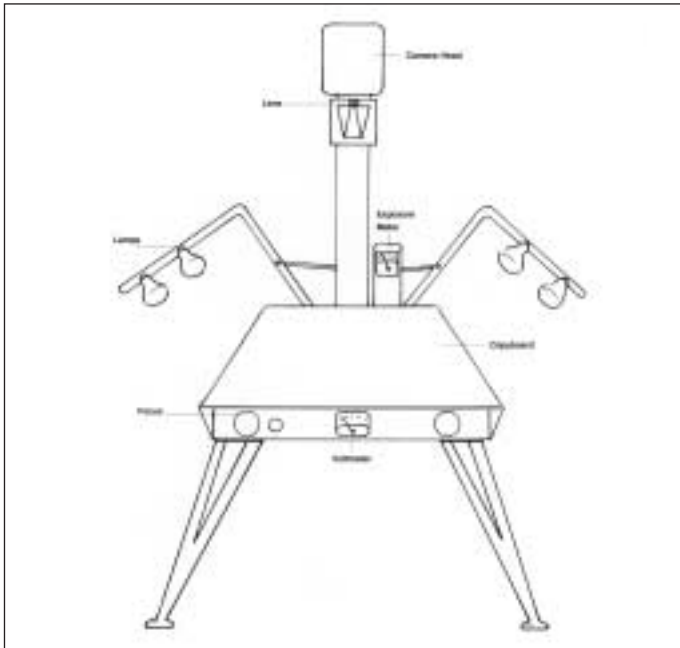

Diagram of a 35mm planetary camera

Copyright: Reproduced by permission from Manual of document microphotography by Michael Gunn, Focal Press, Butterworths 1985.



An automated 16mm camera

© Photograph courtesy of State Library of South Australia



Portable 35mm camera

Copyright: © Reproduced by permission, Pacific Manuscripts Bureau, Australian National University.

Step and repeat cameras

These are essentially planetary cameras that have been specially engineered to produce 105mm microfiche. They are designed to position image frames in standard rows and columns on microfiche.

Hybrid cameras

A new generation of hybrid cameras has been developed. These are capable of both microfilming and digitising.

 Further information about various types of cameras is available from sources such as:

- I Saffady 1990, 2000
- I the websites of G.G. Baker and the Film-based Imaging Association (U.S.).

Features of the camera

The lens

This is one of the most important features of the camera. The best cameras have high quality lenses capable of resolving fine detail. The Hermann and Kraemer camera is one recent example of a microfilm camera with a lens that is capable of resolving very fine detail.

Exposure control

Control of the exposure levels enables camera operators to adjust to variations in the colour and texture of the original materials.

Placing the original

Most cameras have a system for determining where to place the original document so that it will be filmed in the centre of a frame.

Accessories

A common type of accessory is a book cradle. This is used with bound volumes to enable the volumes to open as far as possible. The space down the centre of the cradle supports the spine, while the left and right sides can usually be adjusted for height to avoid excess pressure on the binding structure. Through this adjustment the book cradle allows the pages to flatten under a glass plate so that a sharp image of the original can be taken.

Most of the current models of book cradles are available with **book lifts** that automatically rise and fall with the press of a button. This allows the camera operator to turn pages and make adjustments between exposures.

If the original items to be filmed are heavy or thick, the most appropriate camera will definitely be one which has a book cradle and booklift.

Other camera accessories include:

- I film indexing and retrieval systems
- I light meters for measuring light levels
- I foot pedals for operating camera exposure
- I kits for colour microfilming.

Indexing and retrieval systems

Retrieval systems help to locate individual images on a roll of microfilm. Some cameras can automatically record a number beside each image. Here, retrieval usually involves simply checking an index to identify the roll number and the number of the image.

Another automated method involves placing 'blips' or marks below the image of the roll. Blip-encoded microfilm is used in equipment with special retrieval systems such as reader printers. These retrieval systems have the capacity to count the blips, stop at a specified frame and display the image.

Further information about blips is available from:

- Saffady 1990, pp.135-138
- Saffady 2000, pp.111
- the website of G. G. Baker.



Camera with book lift and cradle in two operating positions

© Photographs courtesy of State Library of South Australia



■ Activity 5.1

Types of cameras and their uses

Describe the type of camera (and accessory) you would use for the following tasks:

a) producing 105mm microfiche

b) filming a large heavy bound volume

c) producing a large high quality image

d) high speed filming of bank cheques

e) filming of large, finely detailed manuscripts (A3 size = 297mm x 420mm)

f) filming of smaller pamphlets, up to 20 pages each, with clear print (A4 size = 210mm x 297mm)

An ideal filming site

When setting up a place to film, look for a site that ideally has the following basic characteristics.

Location

- away from excessive vibrations, such as a lift
- away from corridors and movement of people
- near the original records to save transporting them

Lighting

- controlled overhead and window lighting
- the facility for cameras to be loaded in total darkness, if required

Electricity

- I adequate voltage
- I a circuit free from large power users, such as pumps, or air conditioners
- I a voltage stabiliser should be provided, if power surges are likely

Ventilation and temperature

- I good air circulation and reduction from extremes of temperature

Furniture

- I a strong table for holding a camera for filming
- I a stool, chair or additional tables for storing material before and after filming

The reality—and the challenges

The practical reality of microfilming in different locations around the world can truly test the skills and determination of microfilmmers.

Two excerpts from microfilming projects in Cambodia and Vanuatu give a taste of some of the more difficult challenges facing microfilming operators. It is important to note that both articles were written some time ago, the first in 1991, the second in 1969. Nonetheless, it is easy to identify with similar problems around the world today.

From Cambodia in 1991:

The project nightmares were almost exclusively electrical. All three filming sites had to be rewired from scratch. The National Library, where we had begun, had to be re-done twice before we achieved the necessary standards. Modifications to the structure of the rooms themselves were also necessary to seal them off so they could be air-conditioned. No electrical systems in Cambodia are grounded, and even convincing Khmer that such an arrangement was necessary was difficult...

Once wired, the second problem was electrical supply. Sections of Phnom Penh are often without power for hours or weeks. At the National Library we purchased a generator...

However even when there was electricity, it fluctuated rapidly. Although theoretically it was a 220 supply, we would have power anywhere from 150-270 when on the state power line...

(Ledgerwood 1991)

And from the New Hebrides [now Vanuatu] in 1969:

At the Tangoa Training Institution on Santo, the floor of the missionary's dining room, which doubled as a studio, was so ancient ... that it sagged and caused the camera to wobble every time someone walked across it. At the Melanesian Mission headquarters ... the weather was so humid and the mosquitoes and moths so numerous that it required canny timing to avoid photographing an insect each time the lens shutter was released.

(Langdon, 1973 p.46)

● Reflect 5A

A suitable microfilming site

What are some of the challenges you have faced in finding a suitable site for microfilming?

Discuss your experiences with colleagues.

What did you do to solve some of the problems?

Are there any other features of your current microfilming site that could be practically and simply improved?

Reduction ratios

Reduction ratios are discussed in **Preservation Microfilming—Basics** and in **Preparation for Microfilming**. In these modules the reduction ratio is defined as the relationship between the size of the original document and the corresponding microform image.

Changing the distance between the camera head and the original document being filmed controls the reduction ratio.

Distance between camera head and document	Reduction ratio	Appearance of film images
increase	increase	smaller
decrease	decrease	larger

Different mechanical methods are used for raising and lowering camera heads—some of them manual and others motorised. The operator needs to place the camera head at a specific point, usually identified on an attached scale that lists the available reduction ratios.

When changing reduction ratios on some cameras, it is important that the camera head is moved upwards to the selected ratio to achieve the highest accuracy.

With a lower reduction ratio and a larger image, the quality of an image is potentially higher.

Topics 4 and 5 of the module, **Preparation for Microfilming**, explains how reduction ratio plays an integral part of **image programming**. An estimation of the total number of frames on a reel relates to the reduction ratio and the image orientation (comic or cine).

Some cameras have set or fixed reduction ratios and others have variable reduction ratios.

Determining reduction ratio

Determining the best or optimum reduction ratio depends on:

- I the size of the original
- I the quality of the original material
- I the size of the individual print characters (see **Quality Index** below)
- I the format of microfilm to be produced (e.g. 35mm or 16mm).

Important principles

Two important principles in selecting the reduction ratio:

- I Select the *lowest reduction ratio* that will fit the original item in the frame area.
- I Ensure that the edges of the document are visible in the image.

A simple method

Here is a simple method for selecting reduction ratio:

- I Place the item to be filmed on the copyboard of the camera.
- I Move the camera head up and down, to increase or decrease the reduction ratio until the document just fits inside the designated frame area.

With some cameras the operator just needs to move the camera head up or down to the ratio required, and there are markings on the copyboard for placing the document according to the reduction required.

With some models the focus is automatic, while with others there is a need to adjust the focus each time a new reduction is set.

The Quality Index factor

The reduction ratio should also be selected to bring about a result that is compatible with the Quality Index level required in the specifications.

The Quality Index (QI) system is described in Topics 4 and 5 of **Preservation Microfilming—Basics**, and in the module, **Microform Quality Control Inspection**. It takes into account of the level of detail in original items.

Tables for determining reduction ratios

Some organisations produce their own tables of reduction ratios for individual cameras based on the size (width and height) of the original document. These tables are a short cut to determining the relevant reduction ratio.

The following is an example of a table of reduction ratios for a Kodak MRD camera. The table has been produced and used by staff of the Library and Information Services of Western Australia, and is reproduced with permission. Your own organisation may have similar examples of tables for determining reduction ratios.

MRD reduction ratio - measurement guide (in millimetres)

	16mm		35mm	
Reduction	Width	Height	Width	Height
5	190	76	224	159
6	239	89	268	190
7	267	104	312	221
8	306	124	358	254
9	343	138	402	284
10	380	149	448	317
11	419	163	491	347
12	457	180	537	380
13	494	194	580	411
14	532	207	625	443
15	571	223	669	474
16	608	239	716	505
17	647	255	760	536
18	683	267	804	566
19	725	283	851	598
20	762	291	895	632
21	799	300	940	663
22	835	313	973	691
23	875	315		
24	910	324		
25	950	335		
26	970	341		
27	988	347		

Fixed and variable reduction ratios

Fixed reduction ratios

Some standards and Agreements clearly specify that the same fixed reduction ratio has to be used throughout the filming of a particular title. This is commonly the case with books and serials which are usually the same size all the way through.

A fixed reduction ratio makes the filming more efficient, as there is no need to adjust the camera height. It also makes image programming more accurate.

Variable reduction ratios

With some collections, such as archival scrapbooks, folded maps and illustrations, a change in reduction ratio may be unavoidable due to the wide variation in sizes of the originals. Varying the reduction ratio will allow smaller-sized items to be filmed at lower reduction ratios—which means that greater detail in the originals is captured. The main disadvantage is that the filming process is more labour-intensive.

A compromise

In practice, a compromise reduction ratio that fits most of the documents is usually selected, as it would be very labour-intensive to change the reduction ratio for every single frame.

Here are some common examples of compromises:

Example of size variations	Compromise in reduction ratio
<ul style="list-style-type: none">• most originals are A4 size, with a few A3 size pages	<ul style="list-style-type: none">• set reduction for A4 size• change reduction whenever larger A3 pages need it
<ul style="list-style-type: none">• wide variation of sizes throughout the original materials	<ul style="list-style-type: none">• film at the reduction ratio that fits the larger documents (for efficiency)

Any variations in the reduction ratio should be recorded on the targets.

■ Activity 5.2[✳]

[✳] *These are major activities which require the lecturer/assessor to observe and/or sign off performance details.*

Calculating a reduction ratio

For this activity you will need access to:

- one or more 35mm microfilm cameras
- one or more relevant camera manuals.



You will need to make arrangements to do this activity with your lecturer or assessor present.

Topics 1, 2, 3 & 4

Your task is to calculate the best reduction ratio for the following examples. Follow these steps:

1. **Calculate the best reduction ratio** for the sample items in the table below, using a 35mm camera.
2. **Use the simple method** described above under **A simple method**.
3. **Apply the two principles** described above under **Determining reduction ratio**.
4. **Do not film items**—just locate the frame area on the camera copyboard.
5. **Write in the details of the reduction ratio** on the table for each example. Your assessor will need to verify that you follow the steps correctly and sign off your work in the table below.

Assume the following

- I The single page items all contain text the same size as this book.
- I The filming is *one page per frame*.
- I The mode (cine or comic) has been already specified in the table.

Each example needs to be calculated at the best reduction ratio. It needs to be signed off on the **Activity 5.2** table by your lecturer/assessor before you achieve competency.

Note that with some cameras it may not be possible to view the potential framed area on the copyboard, for example, by using a finder lamp. In these cases, students will need to discuss alternatives with their lecturer/assessor and may need to actually film the samples.

Calculation of reduction ratio using examples below

Size of originals	Mode	List the reduction ratio selected by the operator (e.g. 1:16)	Operator selects the lowest reduction ratio that will fit the original item in the frame area ✓ yes ✗ no	Assessor signature	Date
Example A all pages are A3 size 297mm x 420mm	cine		<input type="checkbox"/>		
Example B all pages are A2 size 420mm x 594mm	cine		<input type="checkbox"/>		
Example C size varies throughout— maximum A3, most are slightly smaller than this— 290 x 410	cine		<input type="checkbox"/>		
Example D most pages are A4 size, but at the end 5 fold-out pages are A3 size.	comic		<input type="checkbox"/>		

Numbers of images per frame and image orientation

The *RLG Guidelines* state that generally printed or bound materials are filmed *two pages per frame*. (Elkington 1992, p.133).

Most newspapers and other oversized volumes are filmed as *single pages per frame*.

Manuscripts and single-leaved items are also usually filmed as **single frames** to avoid the time-consuming process of squarely positioning two loose leaves side by side.

Orientation—quality and economics

The table below summarises the options for quality and economics.

Pages per frame	Orientation	Quality	Economics
one	cine	lower reduction—higher quality	expensive—uses more film than comic mode
two	comic	lower reduction—higher quality	expensive—uses more film than cine mode

The supervisor or project manager will need to decide whether economics or quality is more important when choosing image orientation.

Refer to the diagram in, **Preservation Microfilming—Basics**, Topics 4 and 5, for an illustration of cine and comic mode.

Revise the section on image programming in Topic 5 of Module 3, **Preparation for Microfilming**. This section explains that the number of exposures is usually calculated as one page per frame. However, this number needs to be divided by two if filming two pages per frame (i.e. in positions IIA and IIB).

■ Activity 5.3

Images per frame, image orientation, legibility and economics

For this activity you will need to use the exposure table given in Module 3: **Preparation for microfilming**. This will be found in Topic 5, in the section, **Tables for image programming**.

Using this exposure table, calculate the following:

- a) Width 36cm or 14 inches. Comic (B) mode. Reduction ratio 1:15.
If filming in comic (IIB) mode approximately how many *double frames* could you expect to fit on a 40 metre reel of 35mm film?
-
- b) The same document is now filmed as double frames in cine (IIA) mode. Height 51 cm or 20 inches. What reduction ratio in this mode (IIA,) would be needed to achieve *the same number of double frames* as in a) above?
-
- c) Following on from b) above, which orientation (comic or cine) potentially gives the best legibility/quality image with *two pages per frame*?
-
- d) Which orientation potentially gives the best legibility/quality image with *one page per frame*?
-
- e) Which orientation potentially gives the most economical image with *two pages per frame*?
-

Summary

- Planetary cameras are the main type used in preservation microfilming.
- Selecting an ideal filming site is an important foundation for good quality microfilming
- In selecting the reduction ratio, two important principles are:
 - Select the *lowest reduction ratio* that will fit the original item in the frame area.
 - Ensure that the edges of the document are visible in the image.
- In image orientation:
 - one page per frame in cine mode gives higher quality
 - two pages per frame in comic mode gives higher quality
 - both of these options are expensive.

Checklist

In order to test your understanding of this material, work through the checklist below.

If you can answer 'yes' to each question, and you have completed the activities for this topic, you are now ready for your lecturer or assessor to verify that you:

- I can meet the **performance criteria**
- I have satisfactorily completed the **activities**.

If you are in any doubt about any of the content, you should read through the material again, consult some of the references mentioned in the section entitled **Resources**, talk to your work colleagues or contact your lecturer or mentor.

I can:

- I choose an appropriate camera and accessory (e.g. book cradle) for a given task
- I calculate a reduction ratio to achieve the best legibility
- I choose an image orientation to achieve the best legibility
- I choose an image orientation that achieves the most economical product.

▲ Submit

You are now ready to record in your **Log book** that you:

- I can meet the **performance criteria**
- I have satisfactorily completed the **activities** for this topic.

You can record these by marking off the boxes in the shaded columns with a ✓ **yes** or ✗ **no**.

You can then ask your lecturer or assessor to verify this information.

Topic 5

Operating a microfilm camera

Performance criteria

You will have achieved the performance criteria for this topic when you can:

- I demonstrate correct procedures for loading and operating microfilm cameras
- I apply best practice principles when operating cameras and associated equipment
- I identify occupational health and safety hazards associated with the use of microfilm cameras and accessories.

Camera lights

Lights, action, camera... Proper lighting is the foundation for good filming results. The lights and power control equipment should all be of the highest quality and properly maintained.

Before loading the camera it is important to balance the camera lights. The lights should be positioned so that they produce a uniform density on the film.

A light meter is used to balance camera lights.

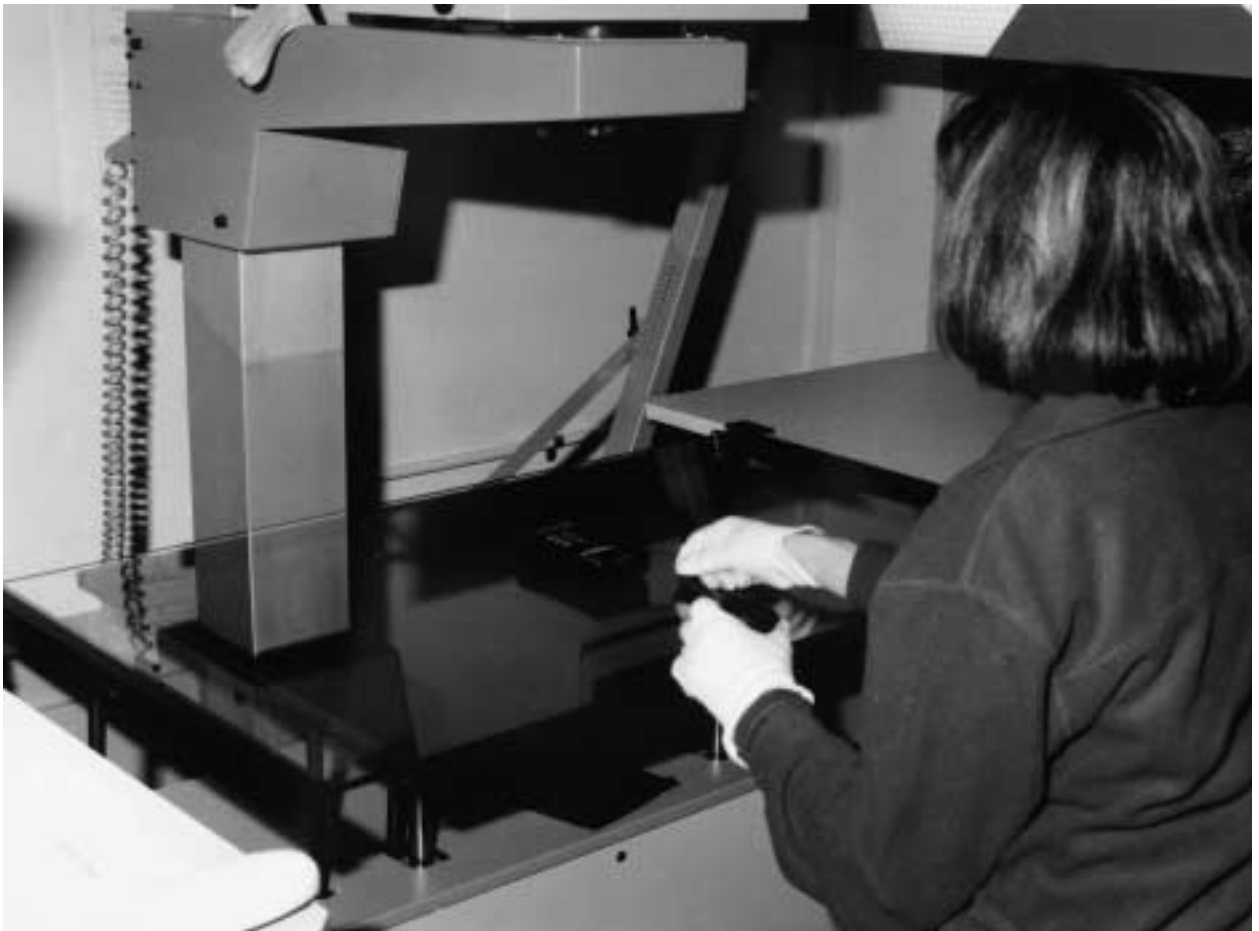

A light meter (centre of copyboard) is used to test and balance camera lights

© Photograph courtesy of State Library of South Australia

Hints and tips for balancing camera light distribution

- I Remember to turn the room lights off when balancing the lights.
- I Check that the camera is away from light sources that will result in uneven illumination on the copyboard—check for reflections from surrounding walls, ceilings and curtains.
- I Do not allow shadows from your body to interfere with light readings.
- I Do not wear light or white clothing, as this can cause reflections.

To balance the camera lights follow the typical steps below:

Step	Comment
1. other lights off	<ul style="list-style-type: none"> • turn off the room lights
2. camera lights on	<ul style="list-style-type: none"> • turn on the camera lights (they can be hot—use a pad to protect your hands)
3. adjust camera lights	<ul style="list-style-type: none"> • if the lights are not already adjusted, start the process by aiming each lamp towards the centre of the nearest edge of the copyboard • see the diagram of a <i>simple light source</i> below
4. take light meter readings	<ul style="list-style-type: none"> • place the light meter in the top left hand corner centre of the copyboard • take the light readings using the light meter • Michael Gunn recommends taking up to 12 readings, as in the <i>light reading</i> diagram below
5. adjust lamps	<ul style="list-style-type: none"> • adjust the lamps (forward, backward, up and down) to achieve the recommended levels of illumination • the recommended levels will usually be specified in the camera manual • as a general rule, with most 35mm cameras, a higher level of illumination will usually be needed in the four corners than in the centre
6. tighten the lamp adjustment knobs	
7. replace whole set when one lamp blows	<ul style="list-style-type: none"> • when one lamp blows the whole set needs to be replaced—it is false economy to just replace the one lamp as this will lead to uneven lighting and expensive retakes

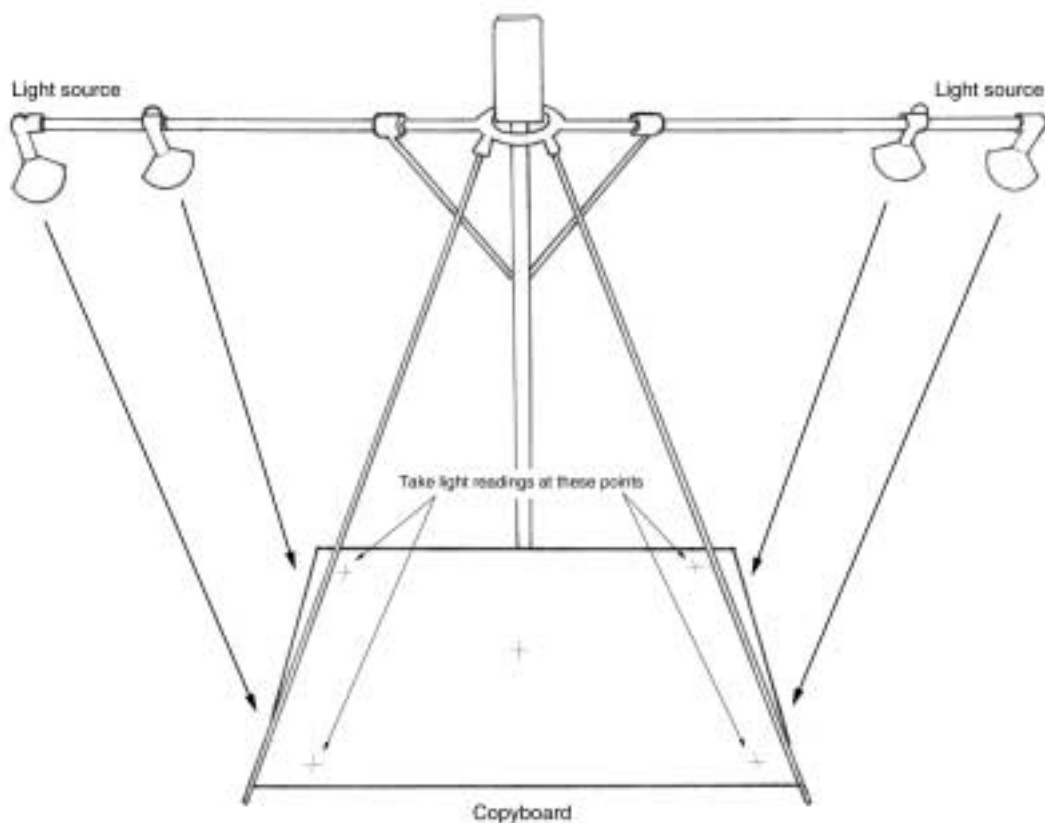

Simple light source

Reprinted by permission. © 1993, 2001 by Intellectual Reserve, Inc. Adapted by the National Library of Australia

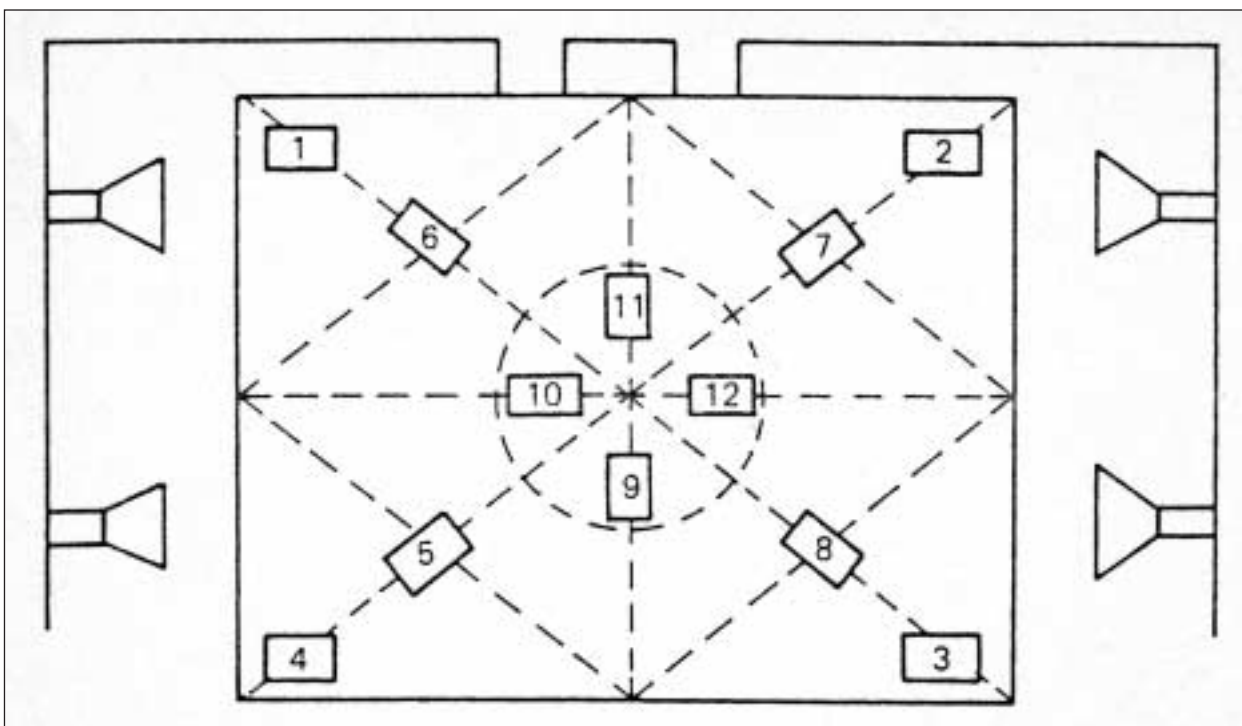

Light reading

The light meter should be placed on the copyboard of the camera in each of the 12 positions shown. Light readings may then be taken for adjustment purposes. A higher level of illumination will usually be needed in the four corners than in the centre.

Uniform density targets

In addition to using a light meter, camera lighting balance should be checked by photographing a large matt sheet of clean uniformly white paper or card at the beginning of each reel. This is known as the **uniform density target**. The sheet must be flat and should be the same size as the largest document being microfilmed.

This test will show whether the lamps are aging at different rates, or have been accidentally moved from their correct position.

Loading cameras

Camera manuals will describe the steps required to load and unload the camera correctly.

The following general principles will apply to many types of camera. Compare the steps below with those needed to load other cameras which you have seen or used.

Loading the camera

1. First, carry out camera cleaning and maintenance steps.
2. Load camera in the dark, or in low lighting, as recommended.
3. Mount and thread a new roll on the supply spindle.
4. Check correct threading through the film path.
5. Check that the film is correctly attached to the take-up spool.
6. Close camera doors.
7. Check that the film travels smoothly through the camera head before starting to film. (Some cameras have an alarm to indicate if film is not loaded correctly)
8. Add leader spaces at the beginning.
+ □ □ □ . . .

9. Film
↓

10. Add trailer spaces at the end, or at a planned break.
+ □ □ □ . . .

11. If only part of film is exposed, cut the film and remove the spool in dark, or low light.



12. If at the end of the film, remove the take-up spool in dark, or low light.

13. Hold the take-up spool to prevent it unraveling, if necessary.

- ↓
14. Place the film in a light-proof container, ready for processing.
-

Now practise loading several different types of cameras, including one 35mm camera. Remember that each camera is unique. Be alert to any special requirements.

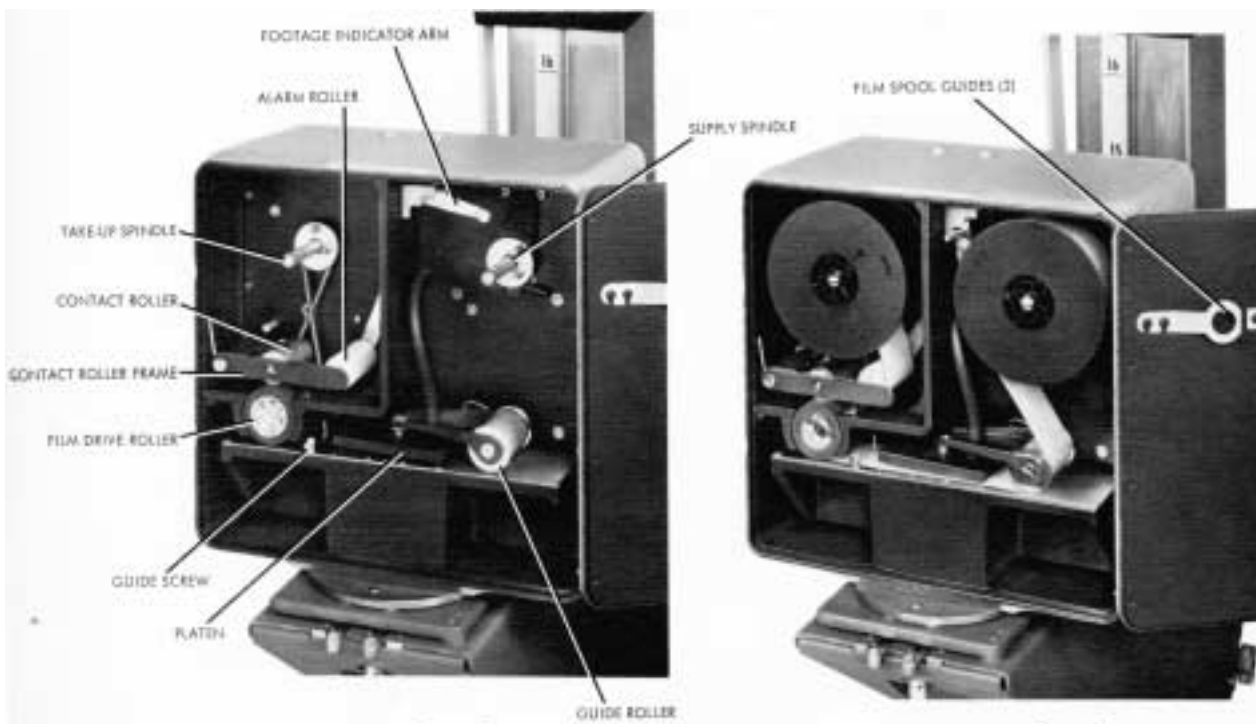

Loading diagrams for a typical 35mm camera

© Reproduced by permission from Kodak

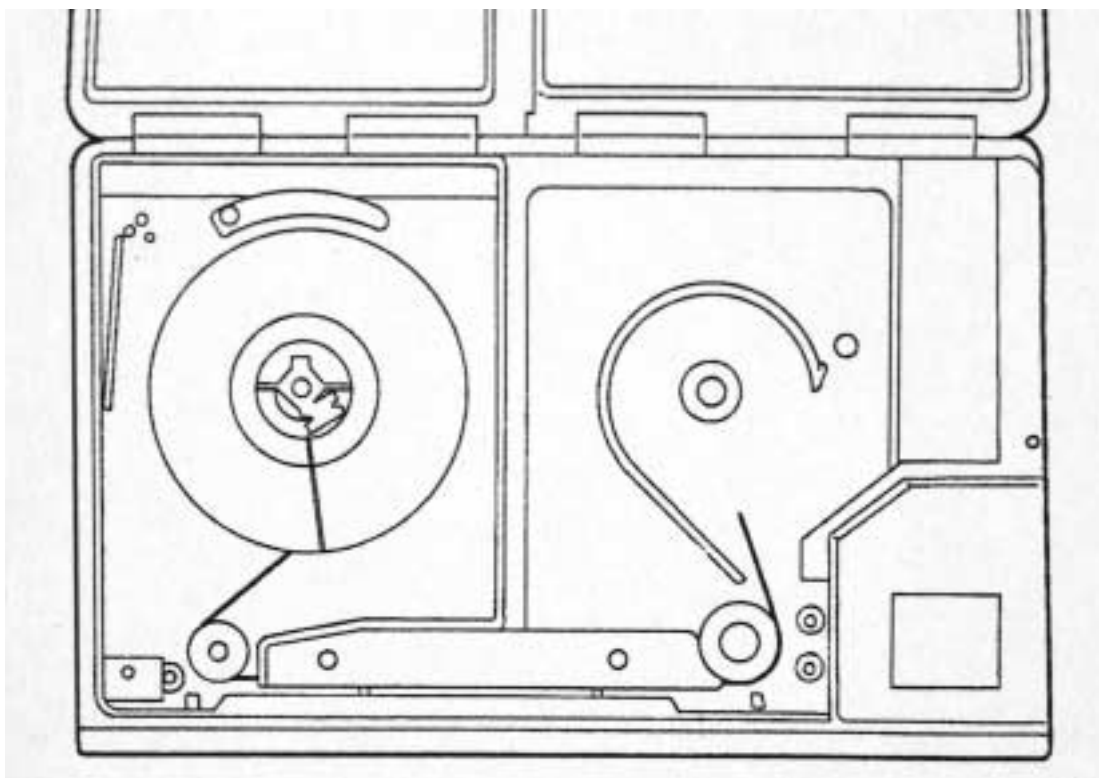

Loading diagram for a typical 16mm camera—the position of the 'supply' and 'take-up' reels may change

© Reproduced by permission from Kodak

■ Activity 5.4*

* These are major activities which require the lecturer/assessor to observe and/or sign off performance details.

Loading a camera

- In the table below list the steps for loading a 35mm camera.
- Load the 35mm camera correctly with film in the presence of your lecturer or assessor.
- Remember to first include the camera maintenance steps.
(See Topic 2 of the module, **Maintaining Microfilming Equipment.**)

Each step needs to be performed correctly and signed off on the **Activity 5.4** sheet before you are competent.



For this activity you will need access to a

- a 35mm microfilm camera
- a reel of 35mm film for making tests
- the camera manual which lists the steps for loading
- a processor to process the results of the camera tests.

You will need to make advance arrangements so that your lecturer or assessor can be present to observe you loading the camera and also doing **Activity 5.5.**

Activity 5.4 and **Activity 5.5** are best completed together.

Steps as detailed in manual	Lecturer/assessor to verify that each step has been performed correctly		
	Correct ✓ yes ✗ no	Assessor signature	Date
Camera maintenance steps			
1. clean the lens, remove dust from inside the camera head with a fine brush	<input type="checkbox"/>		
2. wipe dust etc. from copyboard	<input type="checkbox"/>		
Camera loading steps			
1.	<input type="checkbox"/>		
2.	<input type="checkbox"/>		
3.	<input type="checkbox"/>		
4.	<input type="checkbox"/>		
5.	<input type="checkbox"/>		
6.	<input type="checkbox"/>		
7.	<input type="checkbox"/>		
8.	<input type="checkbox"/>		
9.	<input type="checkbox"/>		
10.	<input type="checkbox"/>		
Test: is the camera correctly loaded?			

Keep the film loaded in the camera ready for **Activity 5.5** below.

Operating cameras—best practice principles

Camera manuals will describe the steps necessary to operate the camera correctly. Best practice also extends to:

- ! steps in maintaining the camera correctly
- ! occupational health and safety issues
- ! practices for dealing with special types of problem materials.

The aim is to produce the highest quality master image, as this will determine the quality of all other copies. ***The better the master, the better the copies.***

Best practice principles: where to place the original item

Determining where to put the original item on the copyboard is one of the first operating tasks. Most camera manuals will give advice on this operation.

- ! Some cameras have marks on the copyboard to help with placement in comic and cine mode.
- ! Some organisations make their own marks on the copyboards to help operators.
- ! Other cameras have features such as a finder lamp that helps operators to pinpoint where to place items within the area to be filmed.

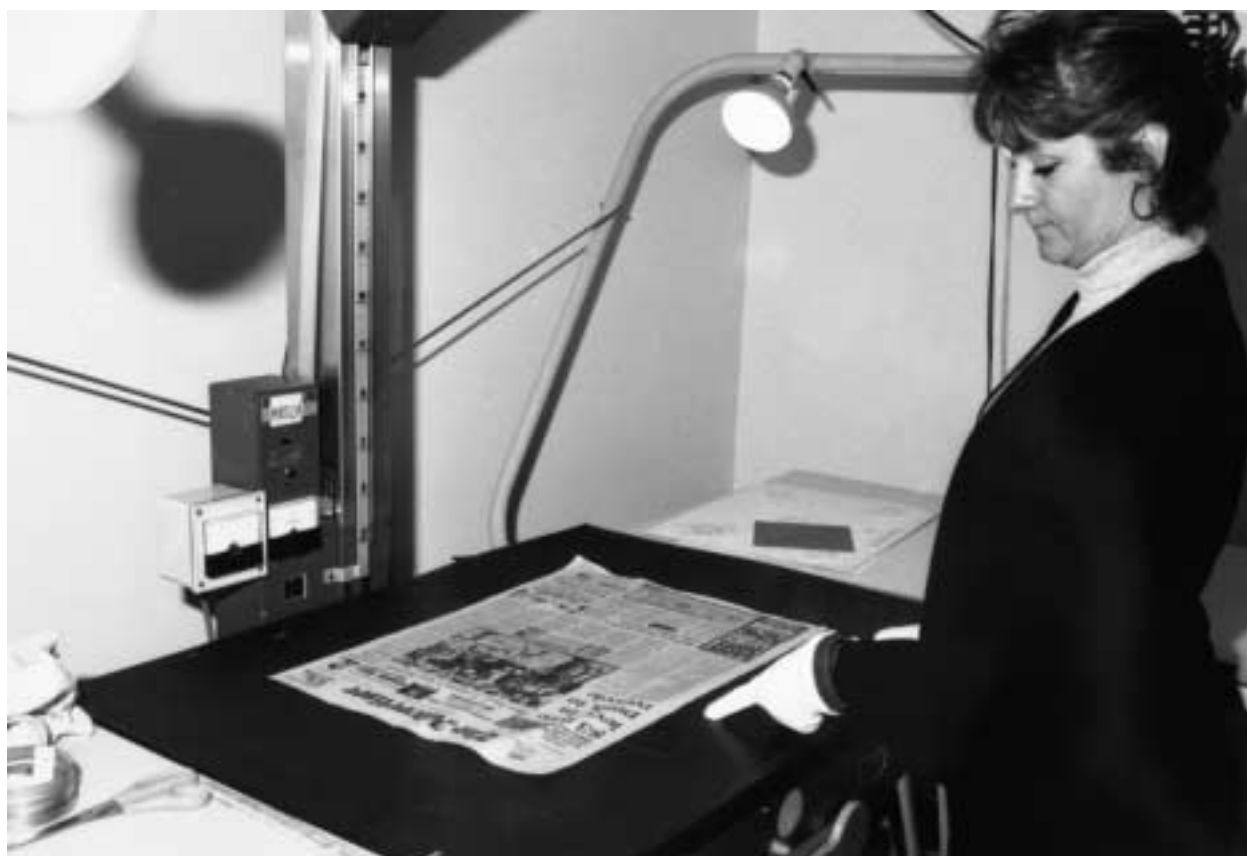

Placing item on the copyboard

© Photograph courtesy of State Library of South Australia

Best practice principles: focus settings

In preservation microfilming the lens must be focused precisely to give the sharpest image and highest resolution.

As the ANSI/AIIM Standard MS23 points out, for any given position of the document and film there is only one perfect position for the lens. This is the true point of true focus. (ANSI/AIIM Standard MS23 1998, p.55) A small variation either side of this point will reduce the sharpness of the image.

All camera models have their own means of determining the focus. For example, the Kodak MRD cameras use a slit light beam to help the operator focus the lens.

The only way to check if a lens is perfectly focused is by photographing and checking a **resolution test chart**. The resolution values will be highest at the point of perfect focus.

Checking resolution is described further in the module, **Microform Quality Control Inspection**.

Best practice principles: knowing the depth of field

The depth of field is the zone in which a document must remain so that the images are acceptably sharp, at a given lens setting.

The ANSI/AIIM Standard MS23 describes depth of field in the following terms:

Just as there is one perfect position for a lens, there is one perfect position for the document. There is however, a certain safety region on either side of the point of perfection, and as long as the document remains within this region during the exposure, the image will be in an acceptable focus range.

(ANSI/AIIM Standard MS23 1998, p.55)

The actual depth of this safety region can be measured and is known as the *depth of field*.

The camera operator needs to keep the documents positioned within the depth of field during the exposure. This can be a problem with thick volumes. These volumes may need to be unbound so that they become single sheets to overcome the depth of field problem.

Best practice principles: exposure levels and step tests

Another best practice principle in operating a camera is determining the exposure levels for filming items.

On most cameras the exposure is regulated through *light intensity*, by altering the voltage applied to the camera lamps or *shutter speed* or time of exposure.

A *step test* can be used to check for the best exposure levels and other camera settings.

Step tests are also made when different types of films and chemicals are being used, as these also affect the density.

The next steps







Check out the example of the effects of underexposure and overexposure on density levels and overall image quality in the module, **Microform Quality Control Inspection**. This example will show you what to look for when you need to select the best density.

Check out the sample of step tests supplied with this module. You will use this sample with the **Reflect 5B** activity below.

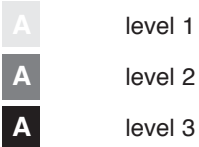
Work your way through the typical stages in a step test which are outlined in the following section. Compare these steps with the film sample.

Camera step tests

The following are typical stages in a camera step test. They are intended as a general guide to give you an understanding of the common steps.

Step	Comments and examples
select range of originals for testing	<ul style="list-style-type: none"> • average pages • different coloured paper • pages where text is very light (low contrast), or very dark (high contrast) • pages using pencil or different coloured inks
film each item at increasing steps of exposure levels 	
note voltage level or shutter speed of each exposure step 	
process film	<ul style="list-style-type: none"> • process the film to manufacturer's standards (see chart 3)
check images for best density 	<ul style="list-style-type: none"> • a densitometer should be used to obtain the most precise readings (check relevant standards)  <p data-bbox="842 1758 1324 1814"><i>Taking a density reading with a densitometer</i> © Photograph courtesy of State Library of South Australia</p>
note best levels and match them with similar items e.g. <ul style="list-style-type: none">  cream pages → level 1  blue pages → level 2  dark brown pages → level 3 	<ul style="list-style-type: none"> • note the exposure levels that give the best density • the exposure levels which result in images with the best densities are then selected for filming similar items

● Reflect 5B

Checking out step tests

- I Visually check out the step test in the sample supplied with this module for the differences in density between the exposure levels. The exposures are in increments.
- I Which levels in your opinion have the best density?
- I Discuss your findings with an experienced colleague.
- I Ask your colleague to explain when and why the step tests are used.

■ Activity 5.5*

* These are major activities which require the lecturer/assessor to observe and/or sign off performance details.

Operating a camera: image placement and doing a step test



For this activity you will need access to:

- I a 35mm microfilm camera already loaded with film from **Activity 5.4**
- I a reel of 35mm film for making tests
- I the camera manual which lists the steps for loading
- I a processor to process the results of the camera tests.

You will need to make advance arrangements so that your lecturer or assessor can be present to observe you doing the tests. **Activities 5.4** and **5.5** are best completed together.

Use the front cover of this booklet as the original item to film, then follow the procedure below.

Task	Description
image placement	<ul style="list-style-type: none"> • place booklet face up on copyboard, in comic mode • it will need to appear in middle of a frame when filmed
do the first series of step tests - comic mode	<ul style="list-style-type: none"> • do a first series of step tests on front cover of this booklet • use at least 3 different exposure levels, beginning with the lowest and moving, step by step, to the highest
spaces	<ul style="list-style-type: none"> • make 10 blank spaces/frames at the end of this first step test
do a second series of step tests - cine mode	<ul style="list-style-type: none"> • repeat the step test with the item in placed in cine mode • it will need to appear in the middle of a frame when filmed • use at least 3 incremental exposure levels
process film	<ul style="list-style-type: none"> • arrange to have the film processed
visually select best density	<ul style="list-style-type: none"> • visually select the image with the best density in first series of step tests—in this activity you do not need to use a densitometer
check image placement	<ul style="list-style-type: none"> • check that the image appears in the middle in both comic and cine mode • check that the image nearly fills the frame

Each step needs to be performed correctly and signed off on the **Activity 5.5** sheet before you achieve competency.

For the lecturer/assessor

Check that the operator completes these tasks in Activity 5.5	Lecturer/assessor to verify that each step has been performed correctly		
	Correct ✓ yes X no	Assessor signature	Date
1. operator winds on leader at beginning	<input type="checkbox"/>		
2. operator places booklet on copyboard face up, in comic mode	<input type="checkbox"/>		
3. operator places booklet so that it will appear the middle of a frame when filmed	<input type="checkbox"/>		
4. operator films step tests with at least 3 increasing exposure levels (in steps)	<input type="checkbox"/>		
5. operator takes note of the voltage, shutter speed or level and films details of these settings with the test	<input type="checkbox"/>		
6. operator makes 10 blank spaces/frames at the end of the first step test	<input type="checkbox"/>		
7. operator places item in cine mode	<input type="checkbox"/>		
8. operator places booklet so that it will appear the middle of a frame when filmed	<input type="checkbox"/>		
9. operator repeats the step test with at least 3 incremental exposure levels	<input type="checkbox"/>		
10. the film is processed	<input type="checkbox"/>		
11. after processing, operator checks that the image appears in the middle and nearly fills the frame in both comic and cine modes	<input type="checkbox"/>		
12. the operator can select the image with the best density from the first series of step tests	<input type="checkbox"/>		

Short cut to exposure levels

A recent article by Normandy Helmer describes a short cut for predetermining exposure levels (Helmer 2001).

- I Select typical samples of originals (e.g. newspapers of varying colours) and label them with letters A, B, C etc.
- I Carry out step tests on each camera to determine the best exposure level for the corresponding samples (e.g. sample A = level 9, sample B = level 8).
- I At the preparation stage, insert flags with the corresponding letters in the newspapers to alert the operator to changes in the colour of the newsprint. Some volumes need only one flag, while others may need ten or more.
- I Each camera has a chart that tells the camera operator what exposure settings to use for the corresponding colour of newsprint.
- I Cameras are always recalibrated to match these same settings.

This system has the potential to shorten ongoing step tests, particularly in cases where it is possible to identify typical samples of originals.

The Pacific Manuscripts Bureau is another example of an organisation that uses a chart of fixed exposure levels for varying densities of documents that have been predetermined by experiment. The chart is used in conjunction with a light meter reading of the document to be filmed. In this case, much of the *filming* of original materials takes place on location in the various South Pacific Islands, and around Australia, but the actual *processing* usually takes place at a micrographics company in Sydney, Australia. Step tests are not normally possible in these conditions, unless special arrangements are made. (Maidment 1998, 2001)

Many other organisations will have similar systems in place to shorten the process of determining exposure levels, especially if the processing is done at another location.

Voltage Meter Calibration	Using 100 watt globes
Settings F8 1/4 second	
White: tested	17
Manila: tested	17
Buff: tested	19
Dark buff (brown): tested	25
Pink: tested	17.5
Light blue: tested	21
Dark blue: tested	25
Light green: tested	19
Lilac: tested	19.5
Yellow: tested	17.5

Example of pre-tested exposure levels

© Reproduced by permission, Pacific Manuscripts Bureau, Australian National University.

● Reflect 5C

Short cuts to exposure levels

Do you have a similar short cut system in your own organisation?

If not, would it be helpful to develop one? How would it work?

Discuss your ideas with your experienced colleagues or supervisor.

Black or white—copyboard colour



There are two schools of thought on the best colour of the copyboard for microfilming.

Advantages of a black copyboard

- Most original materials are light-coloured. Filming on a black background means that holes and document edges can be seen clearly. Dirt and smudges are virtually invisible on the film.
- It is easier to judge density variations when film is being inspected over a light box.
- A black copyboard absorbs light rather than reflects it—so image quality can be improved.
- Document edge detection during scanning of the negative is easier if images are filmed on a black background.

Advantages of a white or light-coloured copyboard

- Items made of thin paper, such as onion skin, are better filmed on lighter coloured backing.
- Document *edges* can be detected on film if items have been exposed properly.
- Use of a light-coloured copyboard means that the camera operator needs to pay special attention to cleanliness and this is a good thing.

If in doubt, it is worthwhile doing step tests with different copyboard backgrounds. The copyboard colour can be easily changed with the use of cloth or backing paper.

The copyboard should be frequently wiped by the camera operator two or three times per reel, to remove particles of paper and other debris which may show up on the film.

Occupational health and safety issues

In the modules, **Preparation for Microfilming** and **Maintaining Microfilm Equipment**, a range of occupational health and safety issues have been discussed. These issues include manual handling, protecting hearing, eyes and feet, handling chemicals and solvents and making sure that equipment is in good working condition.

The following are some key occupational health and safety reminders:

- To avoid injury or accidents, make sure that you and other operators know how to use the equipment properly.
- Do not allow a person to do any task unless they have the skills, experience and understanding to do it safely.
- Operators should be provided with proper training.

Care in using cameras and other accessories

The following occupational health and safety advice relates to using cameras and other accessories such as book cradles:

- ▮ Check equipment to ensure that it is in good working condition, and make regular safety checks of cords, plugs and switches.
- ▮ Use voltage stabilisers, if needed, to maintain a predictable voltage level.
- ▮ Use an earth leakage circuit and/or safety switches
- ▮ Always switch off and unplug equipment before adjusting it.
- ▮ Ask a qualified electrician for advice on your requirements.
- ▮ Wear protective clothing to protect you from the dust of original materials.
- ▮ Protect your feet from the danger of falling objects. In some countries it is not the custom to wear footwear, especially inside. In these cases, think carefully about practical ways of protecting the feet from accidents.
- ▮ Move heavy volumes with others and do not try to lift heavy volumes alone. This will be a temptation when using a book cradle, which is designed for holding heavy thick volumes.
- ▮ Use trolleys to move heavy items. Large bound volumes should be carried by two or more staff. The original document can then be moved simply from one side to the other without the need to turn or twist.

For example:

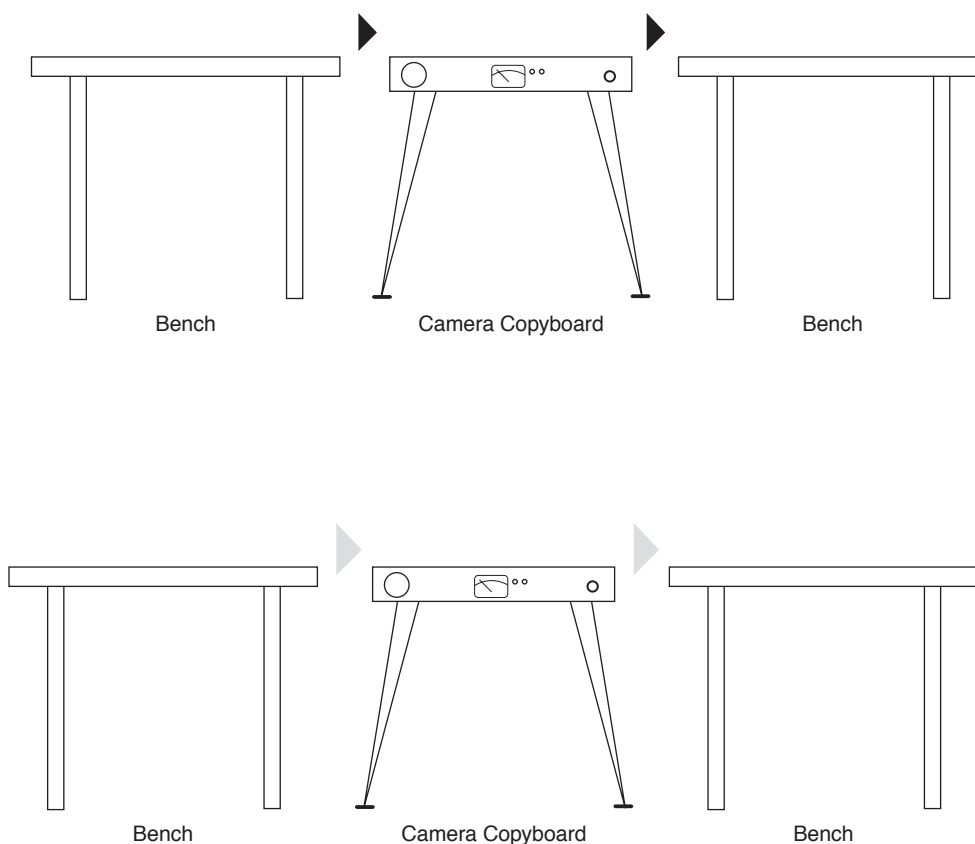

Moving an original document to avoid twisting while filming

● **Reflect 5D**

Special requirements of different types of cameras

Reflect on the different cameras that you have operated and any special requirements of these cameras.

Ask your colleagues about the different cameras they have operated and any special requirements.

What is the easiest camera that you (or your colleagues) have operated and why?

What is the most difficult camera you (or your colleagues) have operated and what made it difficult?

Summary

- I To produce the highest quality master image it is important to develop the high level skills of loading and operating cameras efficiently and effectively.
- I These skills include:
 - balancing camera lighting
 - determining where to place an item
 - setting the focus
 - knowing the depth of field
 - determining exposure levels by performing step tests
 - identifying and avoiding occupational health and safety hazards.

Checklist

In order to test your understanding of this material, work through the checklist below.

If you can answer 'yes' to each question, and you have completed the activities for this topic, you are now ready for your lecturer or assessor to verify that you:

- I can meet the **performance criteria**
- I have satisfactorily completed the **activities**.

If you are in any doubt about any of the content, you should read through the material again, consult some of the references mentioned in the section entitled **Resources**, talk to your work colleagues or contact your lecturer or mentor.

I can:

- I demonstrate correct procedures for loading and operating microfilm cameras
- I apply best practice principles when operating cameras and associated equipment
- I identify occupational health and safety hazards associated with the use of microfilm cameras and accessories.

▲ Submit

You are now ready to record in your **Log book** that you:

- I can meet the **performance criteria**
- I have satisfactorily completed the **activities** for this topic.

You can record these by marking off the boxes in the shaded columns with a ✓ **yes** or ✗ **no**.

You can then ask your lecturer or assessor to verify this information.

Topic 6

Common camera problems

Performance criteria

You will have achieved the performance criteria for this topic when you can:

- I identify common camera problems and their causes in creating preservation-standard microfilm
- I identify ways of overcoming these problems.

Reflect back to **Activity 4.5** in the module, **Maintaining Microfilming Equipment**. This activity gave you experience in identifying common problems, their causes and corrections/adjustments.

You also needed to use the camera manual for trouble-shooting hints and tips. The problems included the following:

- I fogged images
- I density varies greatly from image to image, and within each image
- I blurred, fuzzy image
- I film is not advancing
- I film is broken
- I camera will not operate
- I lamps flickering.

● Reflect 5E

Camera problems, causes and adjustments

Discuss the problems in **Activity 4.5** and your own list of causes and corrections/adjustments with colleagues.

Listen to their experiences with other types of cameras.

Add any additional problems, comments and suggestions to the list below.

Camera type

Additional problems

Probable causes

Corrections/adjustments

Additional problems	Probable causes	Corrections/adjustments

Special filming problems of some original materials

Some original materials present special problems to the camera operator. The following table gives some hints and tips on how some of these problems can be overcome. The table is adapted and reproduced by permission from *RLG Archives Microfilming Manual*, edited by Nancy Elkington, Copyright © 1994 by the Research Libraries Group, Inc.

If originals are...	The camera operator should...
wrinkled, curled, folded, creased	<ul style="list-style-type: none"> smooth material by hand carefully, then place under a plate of tempered glass (edges of glass should be wrapped with black photographic tape) carry out additional step testing to ensure a good image, because placing items under glass may affect the exposure
stained	<ul style="list-style-type: none"> take multiple exposures at different levels if stain is translucent (i.e. you can see through it) to capture all available information if stain is opaque (dark, you cannot see through it) no additional exposures will help
mutilated/torn	<ul style="list-style-type: none"> flag this at the preparation stage with special targets prepared back the item with black to ensure that holes or mutilated areas are clearly visible
low contrast—light paper and light print	<ul style="list-style-type: none"> lower exposure slightly (decrease the amount of light or shorten exposure time) and expose for the density of the paper
low contrast—dark paper and dark print	<ul style="list-style-type: none"> increase exposure and expose for the background density of the paper shoot multiple exposures at different levels to capture all available information
damaged by bleed-through	<ul style="list-style-type: none"> use a black backing and increase exposure in an attempt to fill in the bleed-through consider coloured filters as another possibility
show-through (translucent paper)	<ul style="list-style-type: none"> use a white background and increase exposure
scrapbook pages with layered contents	<ul style="list-style-type: none"> check with project manager—check exposures for variable densities take a first exposure of entire page as it is mask-off overlapped material and take multiple shots to move from top left to bottom right of page (the next section describes scrapbook problems in more detail)
black and white photographs/snapshots	<ul style="list-style-type: none"> increase exposure to get good contrast on film place under glass to reduce curl
newspapers with text and black and white photographs on same page	<ul style="list-style-type: none"> do step tests first to check best exposure levels do multiple exposures at different levels to capture all available information
newspapers with text and black and white and coloured photographs on same page	<ul style="list-style-type: none"> do step tests first to check best exposure levels do multiple exposures at different levels to capture all available information
encapsulated items (e.g. items in a clear cover)	<ul style="list-style-type: none"> expose normally
onion skin, or very thin paper	<ul style="list-style-type: none"> use a white or cream-coloured backing decrease exposure
textured surfaces	<ul style="list-style-type: none"> increase exposure as these surfaces tend to be less reflective be careful not to increase exposure too far, as it may wash out the text

Add your own examples below

Scrapbooks, layered and oversize objects

Scrapbooks and diaries often have pages with layers of objects, for example:

- I folded and overlapping parts, such as pages with fold-out newspaper cuttings, maps, charts and illustrations
- I enveloped parts, as in a diary with letters in pasted down envelopes.

Often individual parts cover up others on the same page. It is important for the user to understand how all the parts relate together.



A scrapbook

© Photograph courtesy of State Library of South Australia

Filming order

1. Film the image on the page as it is found, with all openings closed.
2. Then film each part in logical sequence.
3. Items should be filmed from left to right, top to bottom.
4. Overlaying items should be filmed *before* underlaying items.
5. Envelopes should be filmed *before* their contents.
6. All parts of an item should be filmed *before* the filming of another item begins.
7. Every item on a page should be filmed *before* the filming of another page begins.
8. If necessary, make a special target that maps the position and original arrangement of items on the page:
 - give a unique number to each item which can be filmed before the page, as in the following diagram
 - number the items on this target in the order they are to be filmed
 - add the corresponding number next to each item as it is filmed.

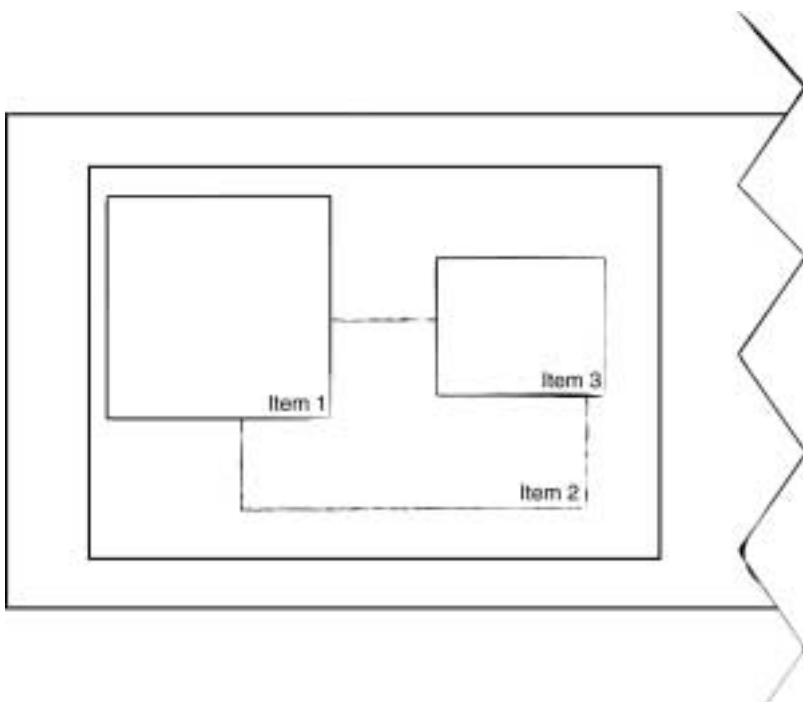

Special target for layers in a scrapbook

Oversize objects

With oversize items a change in the reduction ratio is usually needed. It is common practice for the reduction ratio to be changed so that each oversize image will fit into a single frame.

After the image is filmed, the camera is returned to the original reduction ratio to complete filming of the rest of the documents. Each change in the reduction ratio is noted with targets.

When images are too large to fit legibly into a single frame, the following steps are commonly followed:

- firstly film the large image as a whole at a higher reduction, so that it fits on one frame

- I then film the large image in sections from left to right, and from top to bottom
- I film so that there is an overlap of 1 inch or 2.5 cm between adjacent sections.

Further information is provided in the section on **Variable reduction ratios** in Topics 1, 2, 3 and 4.

Exposure and density

- I With a wide range of paper colours and quality it will be necessary to take multiple exposures of the same frame.
- I You need to take into account multiple exposures when estimating frame counts and project costs.
- I Step tests will need to be taken on different paper colours and inks to determine the best levels for exposing similar types of materials.
- I While standards emphasise minimum variation in background density within a reel, in reality there are many examples of films with wide variations in ranges of background density.
- I These variations make it difficult to duplicate film. The project manager may need to decide on a compromise of average exposure levels.

Summary

To help you and others benefit from experience, it is useful to record:

- I examples of common problems, causes and corrections
- I hints and tips for filming special materials.

Checklist

In order to test your understanding of this material, work through the checklist below.

If you can answer 'yes' to each question, and you have completed the activities for this topic, you are now ready for your lecturer or assessor to verify that you:

- I can meet the performance criteria
- I have satisfactorily completed the activities.

If you are in any doubt about any of the content, you should read through the material again, consult some of the references mentioned in the section entitled Resources, talk to your work colleagues or contact your lecturer or mentor.

I can:

- I identify common camera problems and their causes in creating preservation-standard microfilm
- I identify ways of overcoming these problems.

▲ Submit

You are now ready to record in your **Log book** that you:

- I can meet the **performance criteria**
- I have satisfactorily completed the **activities** for this topic.

You can record these by marking off the boxes in the shaded columns with a ✓ **yes** or ✗ **no**.

You can then ask your lecturer or assessor to verify this information.

Index

A

accessories *See* cameras – accessories

B

blips 5–9
book cradle 5–8
book lift 5–8

C

camera lights 5–19
camera problems 5–36
cameras – accessories 5–8
cameras, faults 5–36
cameras, hybrid 5–8
cameras, loading 5–22
cameras, maintenance – routine 5–22
cameras, operating 5–25
cameras, planetary 5–6
cameras, rotary 5–6
cameras, step and repeat 5–8
cameras, trouble shooting 5–36
charts, filming of 5–14, 5–38
copyboard 5–25, 5–31

D

depth of field 5–26
diaries, filming of 5–38

E

exposure levels 5–26, 5–40
exposure levels, short cut 5–30

F

filming order 5–39
filming problems 5–11, 5–36
filming site 5–10
focus 5–26

H

hybrid cameras *See* cameras, hybrid

I

image orientation 5–16
image programming 5–16
images per frame
See image programming

L

lights *See* camera lights
loading cameras *See* cameras, loading

M

maps, filming of 5–14, 5–38

O

occupational health and safety 5–31
operating cameras *See* cameras, operating
order *See* filming order
oversize objects, filming of 5–39

P

planetary cameras
See cameras, planetary

Q

Quality Index 5–13

R

reduction ratio 5–12
reduction ratio, determining 5–12
reduction ratio, fixed 5–14
reduction ratio, variable 5–14
retrieval systems 5–9
rotary camera *See* cameras, rotary

S

scrapbooks, filming of 5–14, 5–38
step and repeat cameras
See cameras, step and repeat
step tests 5–26

T

target, uniform density 5–22

Background

The training materials have been developed by the National Library of Australia, in collaboration with the State Library of South Australia and under the auspices of IFLA PAC, and will be provided to people within the Asia and Pacific regions as a training resource. The materials will also be used within Australia as part of an accredited TAFE training course.

The training materials consist of 10 modules, 6 wall charts, a Log Book, a Learning Guide and a Glossary/Index. We expect that users will both read a printed version of the materials and download them as PDF files from the National Library of Australia's website – www.nla.gov.au

